



Section E



Empty rectangular box for notes or additional information.



Companhia das Lezírias

CAI2* - 5 e 6 de Julho 2014

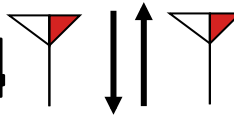

OBSTÁCULO Nº 3

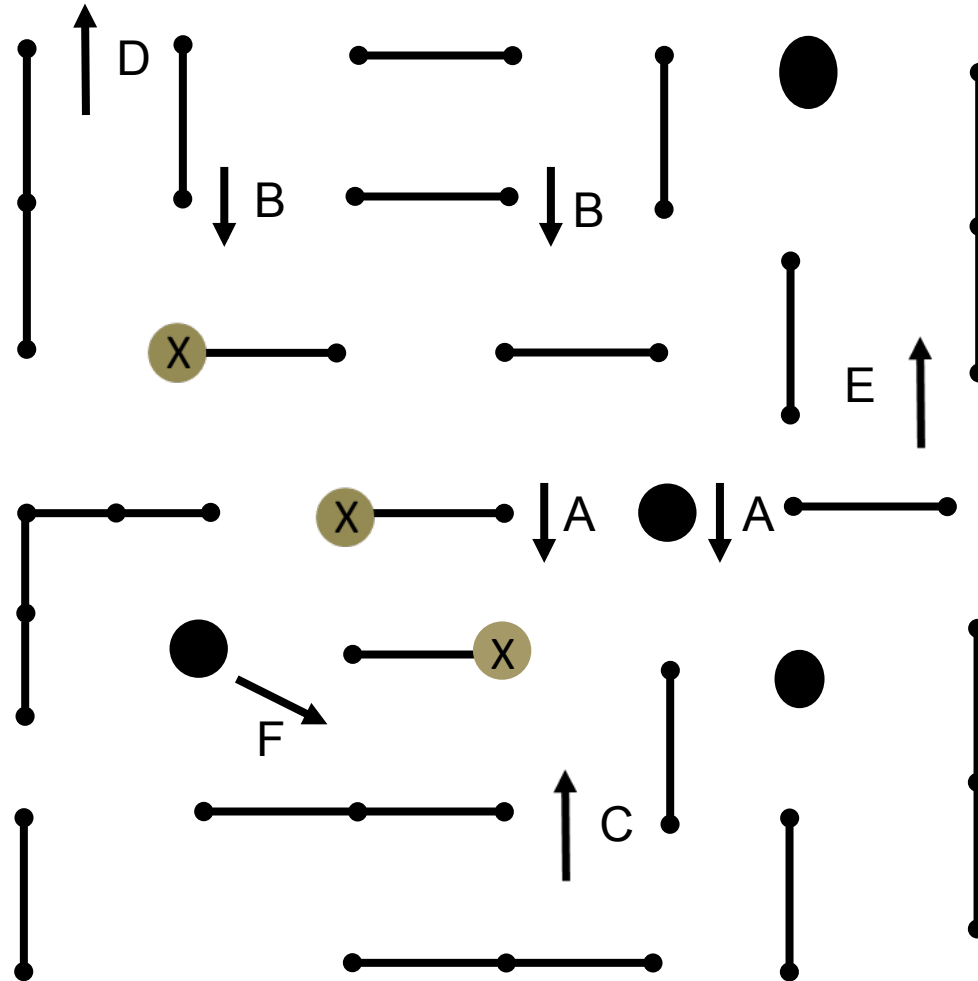



Companhia das Lezírias

CAI2* - 5 e 6 de Julho 2014

OBSTÁCULO Nº 1

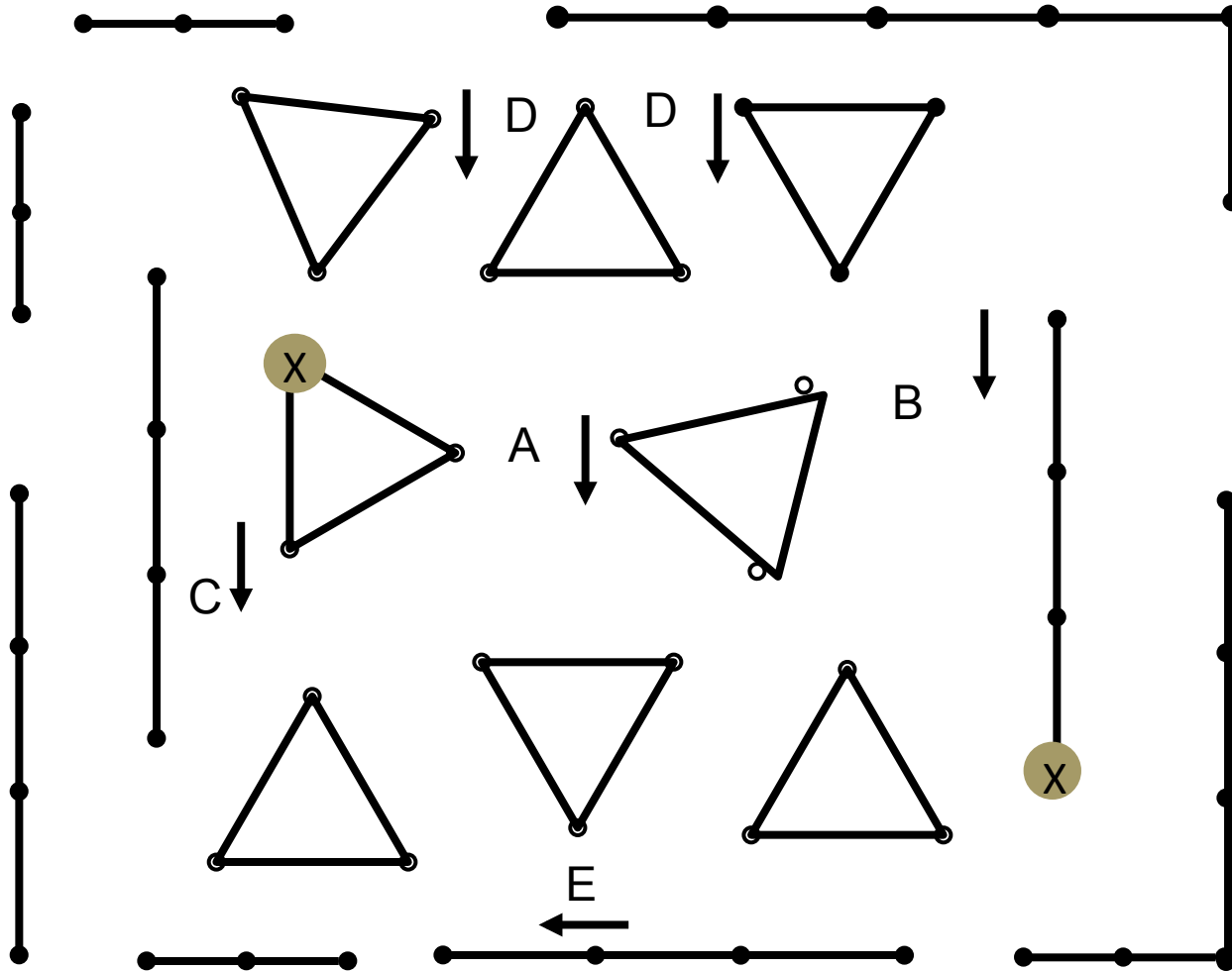
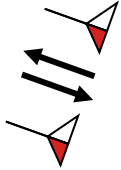



Companhia das Lezírias

CAI2* - 5 e 6 de Julho 2014

OBSTÁCULO Nº 4

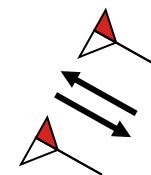
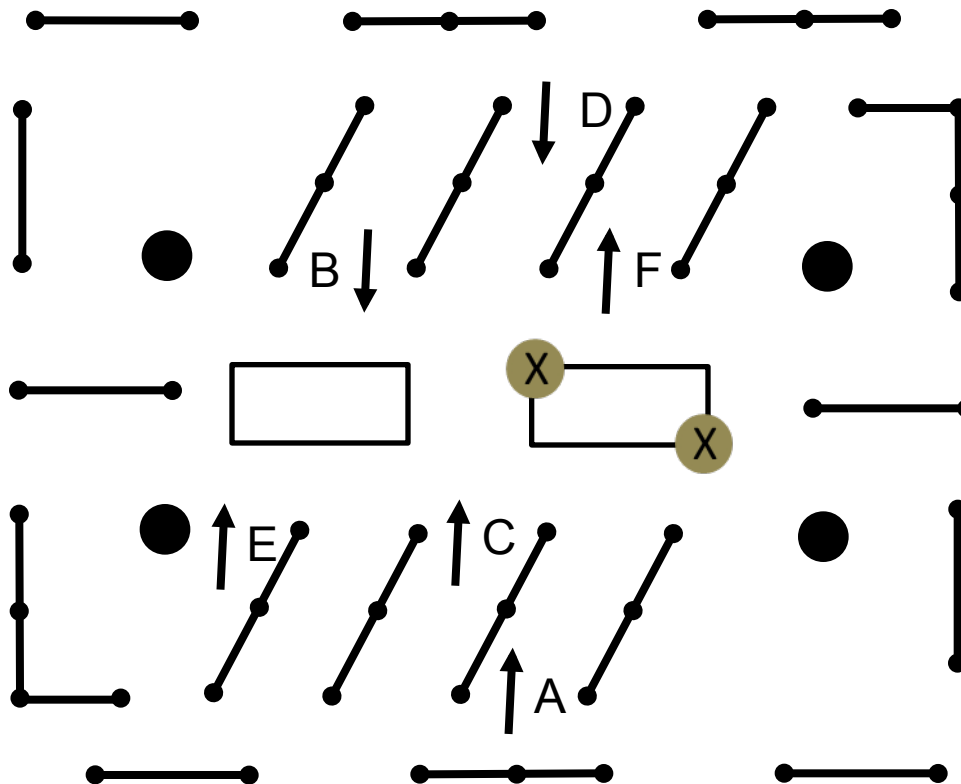



Companhia das Lezírias

CAI2* - 5 e 6 de Julho 2014

OBSTÁCULO Nº ?

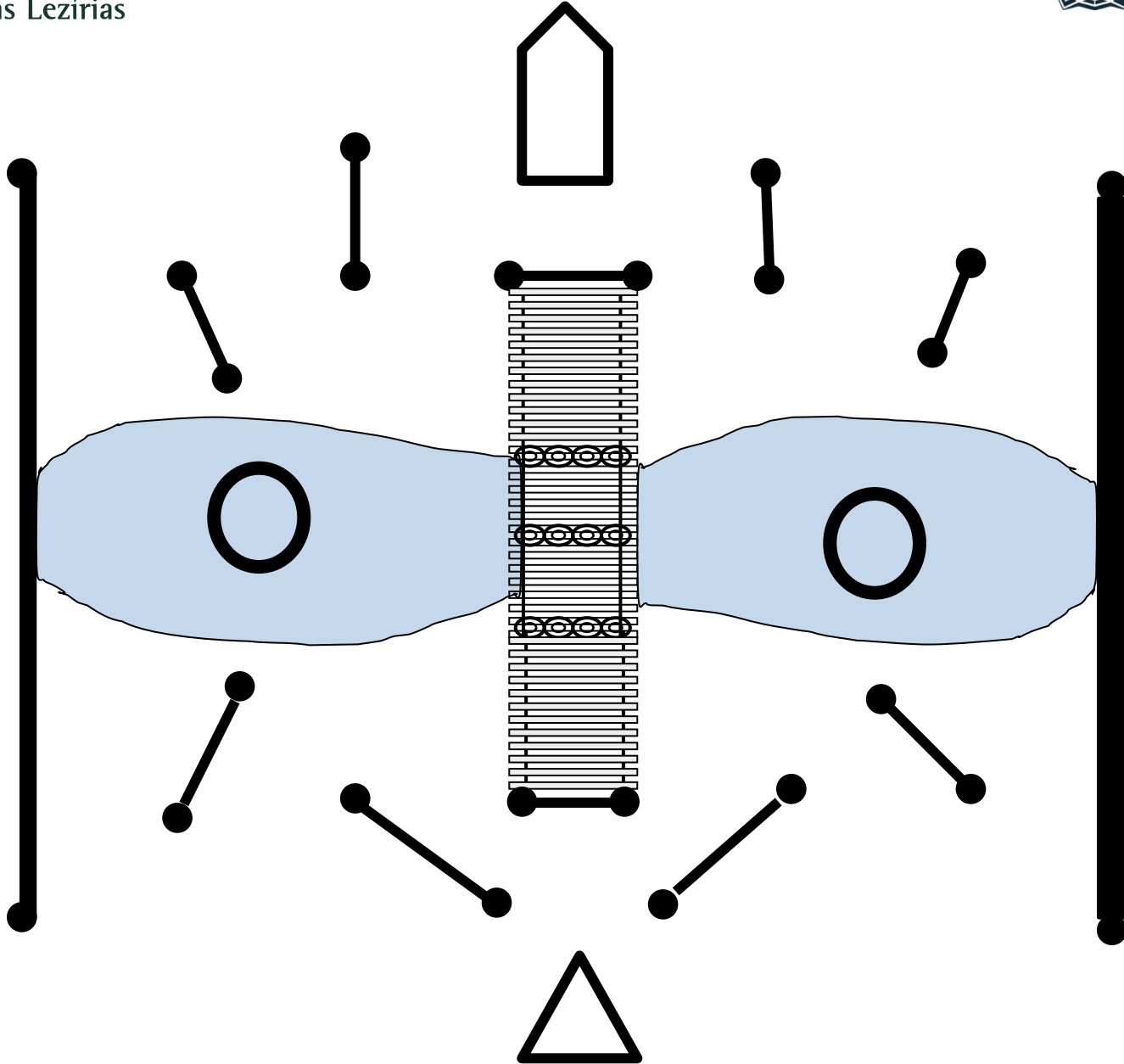



Companhia das Lezírias

CAI2* - 5 e 6 de Julho 2014

OBSTÁCULO Nº ?

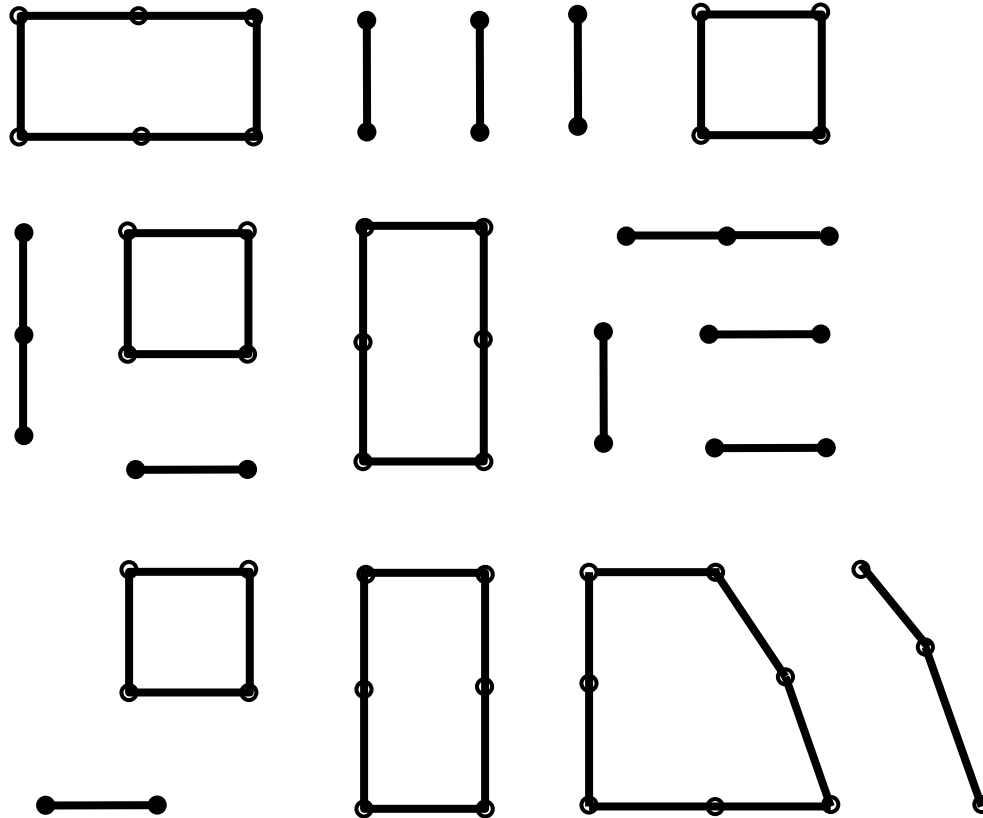



Companhia das Lezírias

CAI2* - 5 e 6 de Julho 2014

OBSTÁCULO Nº 5

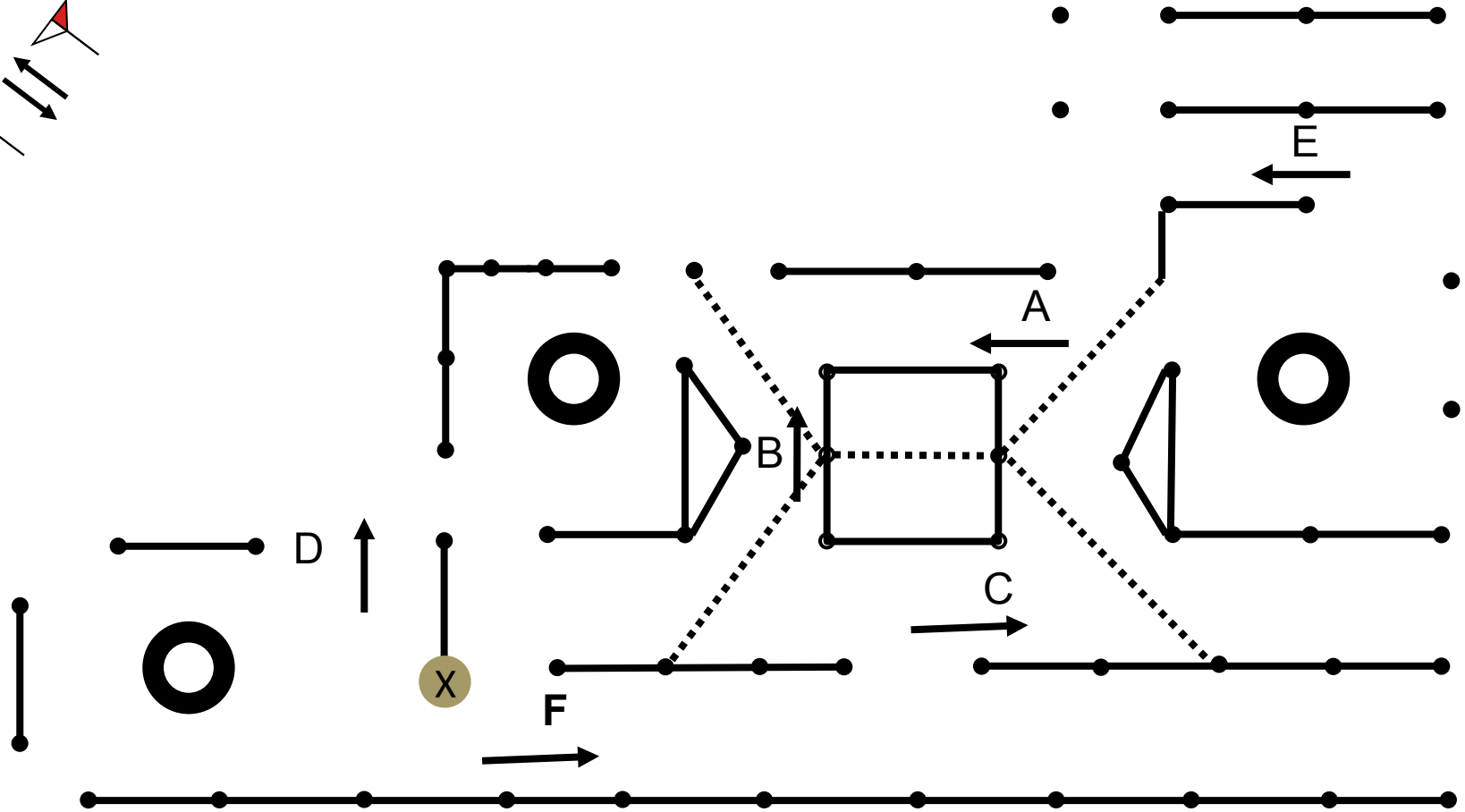
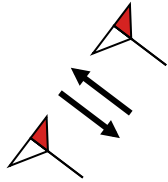



Companhia das Lezírias

CAI2* - 5 e 6 de Julho 2014

OBSTÁCULO Nº 2

